

Panasonic

CD Stereo System

Operating Instructions

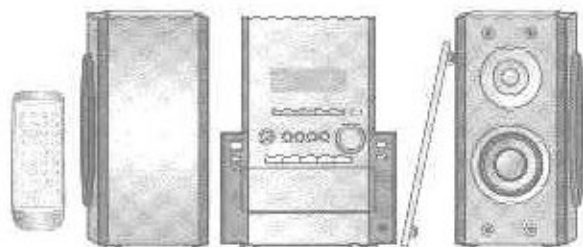

The illustrations show SC-PM27.

Model No. **SC-PM27**
SC-PM17



COMPACT
disc
DIGITAL AUDIO

Before connecting, operating or adjusting this product, please read these instructions completely.
Please keep this manual for future reference.

Dear customer

Thank you for purchasing this product. For optimum performance and safety, please read these instructions carefully.

These operating instructions are applicable to the following system. These operating instructions, however, fundamentally explain the operation of system SC-PM27.

System	SC-PM27	SC-PM17
Main unit	SA-PM27	SA-PM17
Speakers	SB-PM27	SB-PM17

The model number and serial number of this product can be found on either the back or the bottom of the unit. Please note them in the space provided below and keep for future reference.

MODEL NUMBER _____

SERIAL NUMBER _____

User memo:

DATE OF PURCHASE _____

DEALER NAME _____

DEALER ADDRESS _____

TELEPHONE NUMBER _____

WARNING:
 TO REDUCE THE RISK OF FIRE, ELECTRIC SHOCK OR PRODUCT DAMAGE, DO NOT EXPOSE THIS APPARATUS TO RAIN, MOISTURE, DRIPPING OR SPLASHING AND THAT NO OBJECTS FILLED WITH LIQUIDS, SUCH AS VASES, SHALL BE PLACED ON THE APPARATUS.

CAUTION:
 TO PREVENT ELECTRIC SHOCK MATCH WIDE BLADE OF PLUG TO WIDE SLOT, FULLY INSERT.

Table of contents

Before use

- Supplied accessories 3
- IMPORTANT SAFETY INSTRUCTIONS 4
- Placement of speakers 5
- The remote control 5
- Connections 6
- Front panel controls 8

Listening operations

- The radio: manual tuning 10
- The radio: preset tuning 11
- CDs 12
- Cassette tapes 17

Recording operations

- Before recording 18
- Recording from the radio 19
- Recording CDs 19

Timers and others

- Using the built-in sound quality settings 20
- Enhancing the sound quality 20
- Using an external unit 20
- Auto-off function 21
- Turning the demo function off 21
- Setting the time 22
- Convenient functions 22
- Using the timers 23

Reference

- Troubleshooting guide 25
- Warranty (ONLY FOR U.S.A.) 26
- Specifications 27
- Product Service Back cover
- Maintenance Back cover
- When moving the unit Back cover

CAUTION!
 THIS PRODUCT UTILIZES A LASER. USE OF CONTROLS OR ADJUSTMENTS OR PERFORMANCE OF PROCEDURES OTHER THAN THOSE SPECIFIED HEREIN MAY RESULT IN HAZARDOUS RADIATION EXPOSURE. DO NOT OPEN COVERS AND DO NOT REPAIR YOURSELF. REFER SERVICING TO QUALIFIED PERSONNEL.

CAUTION!
 DO NOT INSTALL, OR PLACE THIS UNIT, IN A BOOKCASE, BUILT-IN CABINET OR IN ANOTHER CONFINED SPACE. ENSURE THE UNIT IS WELL VENTILATED. TO PREVENT RISK OF ELECTRIC SHOCK OR FIRE HAZARD DUE TO OVERHEATING, ENSURE THAT CURTAINS AND ANY OTHER MATERIALS DO NOT OBSTRUCT THE VENTILATION VENTS.

Before use

Supplied accessories



Please check and identify the supplied accessories.

Use numbers indicated in parentheses when asking for replacement parts.

(Only for U.S.A.)

To order accessories contact 1-800-332-5368 or web site (<http://www.panasonic.com>).

- AC power supply cord 1 pc.
(RJA0065-A)

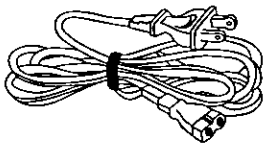

- FM indoor antenna 1 pc.
(RSA0006-L)



- AM loop antenna 1 pc.
(RSA0033A-1)

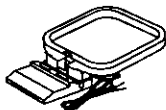

- Remote control transmitter 1 pc.
(EUR648264)



- Remote control batteries 2 pcs.



THE FOLLOWING APPLIES ONLY IN THE U.S.A.

CAUTION:

This equipment has been tested and found to comply with the limits for a Class B digital device, pursuant to Part 15 of the FCC Rules.

These limits are designed to provide reasonable protection against harmful interference in a residential installation. This equipment generates, uses and can radiate radio frequency energy and, if not installed and used in accordance with the instructions, may cause harmful interference to radio communications. However, there is no guarantee that interference will not occur in a particular installation. If this equipment does cause harmful interference to radio or television reception, which can be determined by turning the equipment off and on, the user is encouraged to try to correct the interference by one or more of the following measures:

- Reorient or relocate the receiving antenna.
- Increase the separation between the equipment and receiver.
- Connect the equipment into an outlet on a circuit different from that to which the receiver is connected.
- Consult the dealer or an experienced radio/TV technician for help.

Any unauthorized changes or modifications to this equipment would void the user's authority to operate this device.

This device complies with Part 15 of the FCC Rules. Operation is subject to the following two conditions: (1) This device may not cause harmful interference, and (2) this device must accept any interference received, including interference that may cause undesired operation.

	CAUTION RISK OF ELECTRIC SHOCK DO NOT OPEN	
<p>CAUTION: TO REDUCE THE RISK OF ELECTRIC SHOCK, DO NOT REMOVE SCREWS. NO USER-SERVICEABLE PARTS INSIDE. REFER SERVICING TO QUALIFIED SERVICE PERSONNEL.</p>		



The lightning flash with arrowhead symbol, within an equilateral triangle, is intended to alert the user to the presence of uninsulated "dangerous voltage" within the product's enclosure that may be of sufficient magnitude to constitute a risk of electric shock to persons.



The exclamation point within an equilateral triangle is intended to alert the user to the presence of important operating and maintenance (servicing) instructions in the literature accompanying the appliance.

Before use

IMPORTANT SAFETY INSTRUCTIONS

Read these operating instructions carefully before using the unit. Follow the safety instructions on the unit and the safety precautions listed below. Keep these operating instructions handy for future reference.

Safety

1. **Power source**—Connect the unit to a power source of the type described in these instructions or as marked on the unit.
2. **Polarization**—The unit is equipped with a polarized power plug where one blade is wider than the other. This safety feature ensures that the plug fits into your household AC outlet only one way. If the plug doesn't fit one way, try reversing it. If the plug still doesn't fit, contact an electrician to replace the obsolete outlet. Do not attempt to defeat the safety purpose of the plug.
3. **Power cord protection**—Route the AC power supply cord so that it will not be walked on or pinched by items placed on or against it. Never take hold of the plug or cord with wet hands. Always grasp the plug body firmly when connecting and disconnecting it.
4. **Overloading**—When connecting the AC power supply cord, be careful not to overload the household AC outlet, extension cord, or outlet from any other device as this can result in fire or electric shock.
5. **Nonuse periods**—Turn the unit off when it is not in use. Unplug the unit from the household AC outlet if it is not to be used for a long time. Unplug the unit during lightning storms.
6. **Attachments and accessories**—Use only the attachments and accessories recommended in these operating instructions.

Installation

Placement

1. **Ventilation**—Situate the unit so that it receives proper ventilation. Do not install in a confined space such as a bookcase or cabinet. Allow at least 10 cm (4 inches) clearance from the rear of the unit. To prevent the risk of electric shock or fire due to overheating ensure curtains and other materials do not obstruct the unit's ventilation.
2. **Foreign material**—Ensure objects and liquids do not get into the unit. Avoid exposing the unit to excessive smoke, dust, mechanical vibration, and shock.
3. **Magnetism**—Situate the unit away from equipment and devices that generate strong magnetic fields.
4. **Stacking**—Do not place heavy objects on top of this unit.
5. **Surface**—Place the unit on a flat, level surface.
6. **Carts and stands**—Use the unit only with carts and stands recommended by the manufacturer. Move carts with care. Sudden stops, excessive force, and uneven surfaces can cause carts to overturn.
7. **Wall and ceiling mounting**—Do not mount the unit on walls or ceilings unless specified in the instructions.



Environment

1. **Water and moisture**—Do not use the unit near water, such as near a bathtub or swimming pool. Avoid damp basements.
2. **Heat**—Situate the unit away from heat sources, such as radiators. Do not situate where temperatures fall below 5°C (41°F) or rise above 35°C (95°F).

3. **Power lines**—Take care when setting up an outdoor antenna that it is not near overhead power lines, electric lights, or electrical circuits, and that there is no danger of the antenna falling on power lines, electric lights, or electrical circuits. When installing an outdoor antenna, take extreme care not to touch such power lines or circuits, as contact with them can be fatal.
4. **Outdoor antenna grounding**—If you connect an outdoor antenna, ground the antenna system to protect against voltage surges and built-up static charges. Section 810 of the National Electrical Code, ANSI/NFPA No. 70-1990, provides information about grounding of the mast and supporting structure, grounding of the lead-in wire to an antenna discharge unit, size of grounding conductors, location of antenna-discharge unit, connection to grounding electrodes, and requirements for the grounding electrode. Refer to this diagram.

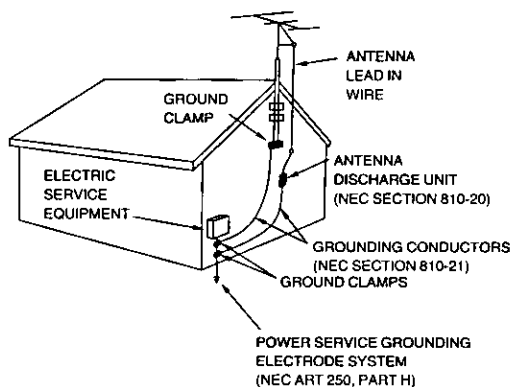

NEC—NATIONAL ELECTRICAL CODE

Maintenance

(See back cover for details.)

Unplug the unit from the household AC outlet before cleaning. Clean with a damp cloth. Do not use abrasive pads, scouring powders, or solvents.

Service

1. **Damage requiring service**—The unit should be serviced by qualified service personnel if:
 - (a) The AC power supply cord or the plug has been damaged; or
 - (b) Objects or liquids have gotten into the unit; or
 - (c) The unit has been exposed to rain; or
 - (d) The unit does not operate normally or exhibits a marked change in performance; or
 - (e) The unit has been dropped or the cabinet damaged.
2. **Servicing**—Do not attempt to service the unit beyond that described in these operating instructions. Refer all other servicing to authorized servicing personnel.
3. **Replacement parts**—When parts need replacing ensure the servicer uses parts specified by the manufacturer or parts that have the same characteristics as the original parts. Unauthorized substitutes may result in fire, electric shock, or other hazards.
4. **Safety check**—After repairs or service, ask the servicer to perform safety checks to confirm that the unit is in proper working condition.

Listening caution



Selecting fine audio equipment such as the unit you've just purchased is only the start of your musical enjoyment. Now it's time to consider how you can maximize the fun and excitement your equipment offers. This manufacturer and the Electronic Industries Association's Consumer Electronics Group want you to get the most out of your equipment by playing it at a safe level. One that lets the sound come through loud and clear without annoying blaring or distortion—and, most importantly, without affecting your sensitive hearing.

We recommend you to avoid prolonged exposure to excessive noise.

Sound can be deceiving. Over time your hearing "comfort level" adapts to higher volumes of sound. So what sounds "normal" can actually be loud and harmful to your hearing. Guard against this by setting your equipment at a safe level BEFORE your hearing adapts.

To establish a safe level:

- Start your volume control at a low setting.
- Slowly increase the sound until you can hear it comfortably and clearly, and without distortion.

Once you have established a comfortable sound level:

- Set the dial and leave it there.

Taking a minute to do this now will help to prevent hearing damage or loss in the future. After all, we want you listening for a lifetime.

Placement of speakers

SC-PM27

Place the speakers so that the super woofer is on the outside.

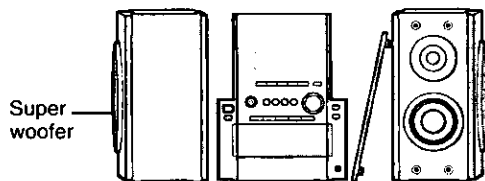

SC-PM17

Speakers are designed identically so that no left or right channel orientation is necessary.

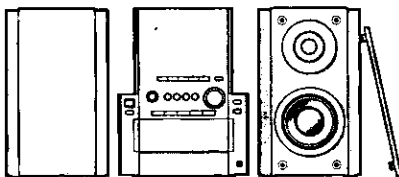

Notes

• Keep your speakers at least 10mm ($1/32$ ") away from the system for proper ventilation.

• **SC-PM27** only

The super woofers are located on the sides of the speakers. Leave 10-cm clearance for them to be effective.

• These speakers do not have magnetic shielding. Do not place them near televisions, personal computers or other devices easily influenced by magnetism.

• To avoid damage to the speakers, do not touch the speaker cones if you have taken the nets off.

The remote control

Battery installation

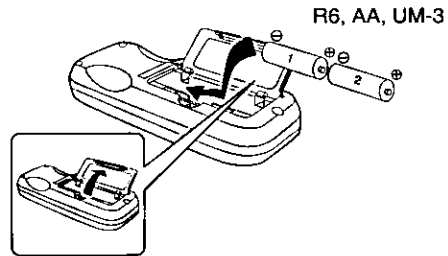

Use of batteries

- Align the poles (+ and -) properly when inserting the batteries.
- Do not mix old and new batteries or different types of batteries.
- Do not recharge ordinary dry cell batteries.
- Do not heat or disassemble the batteries. Do not allow them to contact flame or water.
- Remove the batteries if the unit is not to be used for a long time.
- Do not keep together with metallic objects such as necklaces.
- Do not use rechargeable type batteries.
- Do not use batteries if the covering has been peeled off.

Mishandling of batteries can cause electrolyte leakage which can damage items the fluid contacts and may cause a fire.

If electrolyte leaks from the batteries, consult your dealer.

Wash thoroughly with water if electrolyte comes in contact with any part of your body.

Correct method of use

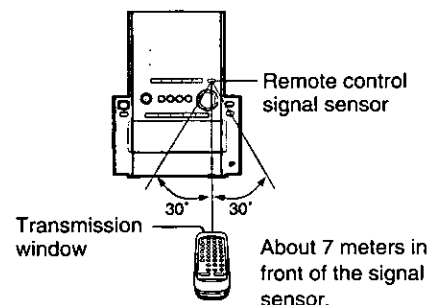

Operation notes

- Do not place obstacles between the remote control signal sensor and remote control unit.
- Do not expose the remote control signal sensor to direct sunlight or to the bright light of a fluorescent light.
- Take care to keep the remote control signal sensor and the end of the remote control unit free from dust.
- If this system is installed in a rack with glass doors, the glass doors' thickness or color might make it necessary to use the remote control unit a shorter distance from the system.

To prevent damage

- Never place heavy items on top of the unit.
- Do not disassemble or reconstruct the unit.
- Do not spill water or other liquids into the unit.

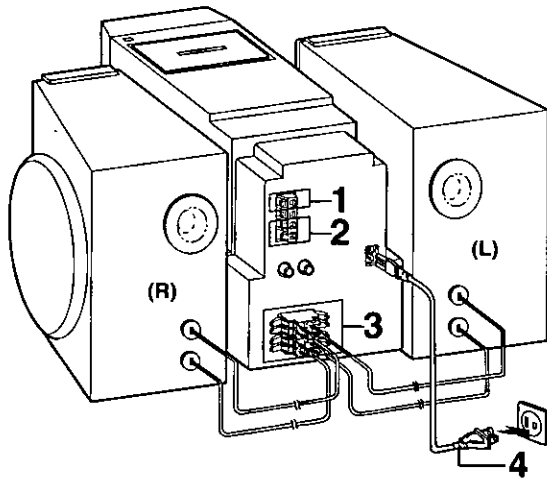

Connections

- Plug the AC power supply cord into a household AC outlet only after all other connections have been made.
- To prepare the AM loop antenna wire and speaker cords, twist the vinyl cover tip and pull off.

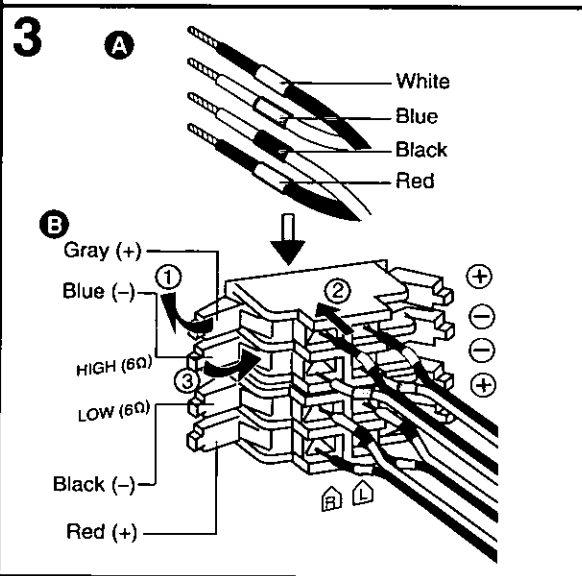
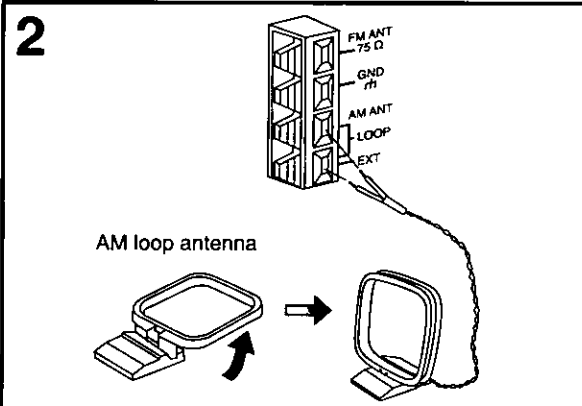
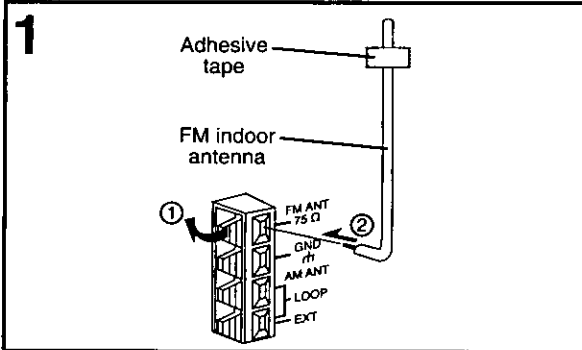
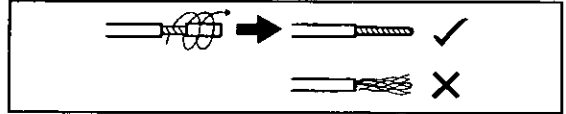

1 Connect the FM indoor antenna.
Tape the antenna to a wall or column, in a position where radio signals are received with the least amount of interference.

Note

For the best reception:

An FM outdoor antenna is recommended. (→ page 7)

2 Connect the AM loop antenna.
Stand the antenna up on its base. Keep loose antenna cord away from other wires and cords.

3 Connect the speaker cords.
A Confirm the colors of the tags on the ends of the cords.

B For White tags:

Connect cords to gray terminals.

For Blue, Black and Red tags:

Connect cords so tag colors match the terminal colors.

Cords with white and blue tags are for high frequency.
Cords with red and black tags are for low frequency.

Incorrect connection can damage the unit.

Caution

Use only the supplied speakers.

The combination of the main unit and speakers provide the best sound. Using other speakers can damage the unit and sound quality will be negatively affected.

Caution

- **Use the speakers only with the recommended system.**
Failure to do so may lead to damage to the amplifier and/or the speakers, and may result in the risk of fire. Consult a qualified service person if damage has occurred or if you experience a sudden change in performance.
- **Do not attach these speakers to walls or ceilings.**

4 Connect the AC power supply cord.

Note

The included AC power supply cord is for use with this unit only. Do not use it with other equipment.

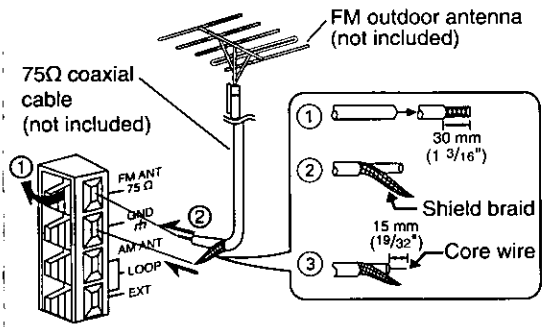
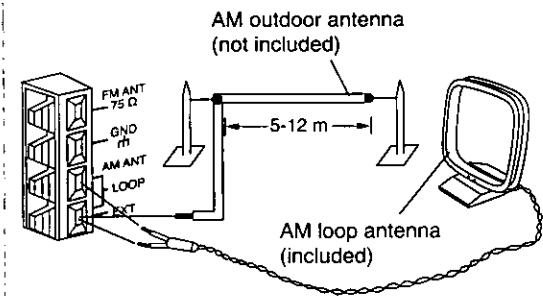
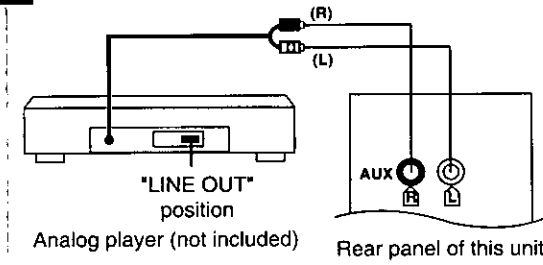
A**B****C**

Connections

Optional antenna connections

You may need an outdoor antenna if you use this system in a mountainous region or inside a reinforced-concrete building, etc.

A FM outdoor antenna

Disconnect the FM indoor antenna if an FM outdoor antenna is installed.

Note

An outdoor antenna should be installed by a qualified technician only.

B AM outdoor antenna

Connect the outdoor antenna without removing the AM loop antenna. Run 5 to 12 m of vinyl-covered wire horizontally along a window or other convenient location.

Note

When the unit is not in use, disconnect the outdoor antenna to prevent possible damage that may be caused by lightning. Never use an outdoor antenna during an electrical storm.

External unit connections

- Make sure that the power supply for all components has been turned off before making any connections.
- For details, refer to the operating instructions of the unit which is to be connected.
- All peripheral components and cables sold separately.

C Connecting analog equipment

This example shows how to connect an analog player with a PHONO OUT/LINE OUT switch. When units other than those described are to be connected, please consult your audio dealer.

Note

- Only an analog player with a built-in phono equalizer can be connected.
- Set the switch to the "LINE OUT" position at the back of the analog player.

Before use

Front panel controls

Main unit

Before use

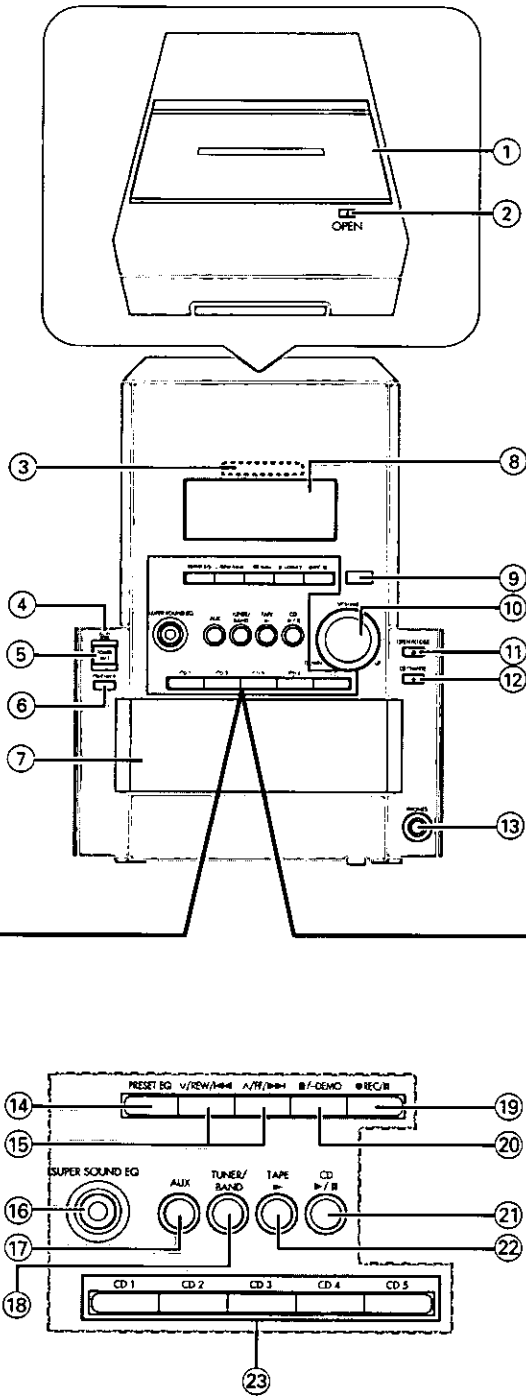

- ① **Cassette lid**
- ② **Cassette open button (△ OPEN)** 17
- ③ **Tape indicator**
This indicator changes in the following manner:
 - Ⓐ Orange (when no cassette is inserted.)
 - Ⓑ Green (when cassette is inserted.)
 - Ⓒ Red (when in recording mode.)
- ④ **AC supply indicator (AC IN)**
This indicator lights when the unit is connected to the AC mains supply.
- ⑤ **Standby/on switch (⏻/⏻ POWER)**
Press to switch the unit from on to standby mode or vice versa. In standby mode, the unit is still consuming a small amount of power.
- ⑥ **CD check button (CD CHECK)** 13
- ⑦ **CD trays**
- ⑧ **Display**
- ⑨ **Remote control signal sensor**
- ⑩ **Volume control (VOLUME DOWN, UP)** 10, 12, 17
- ⑪ **CD tray open/close button (△ OPEN/CLOSE)** 12
- ⑫ **CD change button (△ CD CHANGE)** 13
- ⑬ **Headphone jack (PHONES)** 20
- ⑭ **Preset EQ select button (PRESET EQ)** 20
- ⑮ **CD skip/search, tape fast-forward/rewind/TPS, tune/preset channel select, time adjust buttons (V/REW/⏪, ⏩/FF/▶▶)** 10, 11, 12, 17, 22
- ⑯ **Super sound EQ button (SUPER SOUND EQ)** 20
- ⑰ **Aux button (AUX)** 20
- ⑱ **Tuner/band select button (TUNER/BAND)** 10
- ⑲ **Recording start/pause button (● REC/II)** 19
- ⑳ **Stop/program clear and demonstration button (■/DEMO)** 12, 16, 17, 21
- ㉑ **CD play/pause button (▶/II CD)** 12
- ㉒ **Cassette play button (▶ TAPE)** 17
- ㉓ **Disc direct play buttons (CD 1-CD 5)** 12

Front panel controls

Remote Control

Buttons such as 5 function in exactly same way as the buttons on the main unit.

- 24 Sleep timer/auto off button
(SLEEP, -AUTO OFF) 21, 24
- 25 Numeric buttons (≥10, 1-9, 0) 11, 15
- 26 Display button (DISPLAY) 15
- 27 Dimmer button (DIMMER) 22
- 28 Clock/timer button (CLOCK/TIMER) 22, 23, 24
- 29 Play timer/recording timer button
(PLAY/REC) 23
- 30 Disc button (DISC) 14
- 31 CD Program, tuner preset button
(PROGRAM) 11, 16
- 32 Play mode select button
(PLAY MODE) 10, 14, 15, 19
Use this for selecting repeat mode, CD play mode, tune mode, FM mode and AM beat proof function.
- 33 Stop/program clear button (■/CLEAR) 12, 16, 17
- 34 Muting button (MUTING) 22

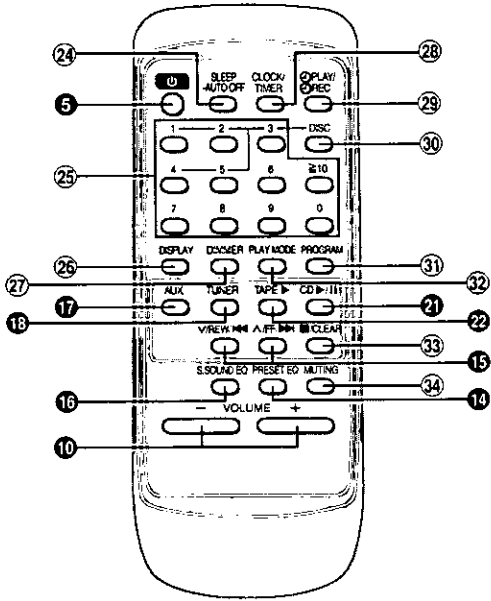

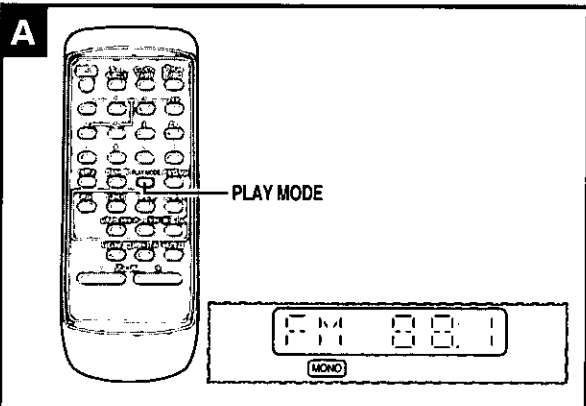
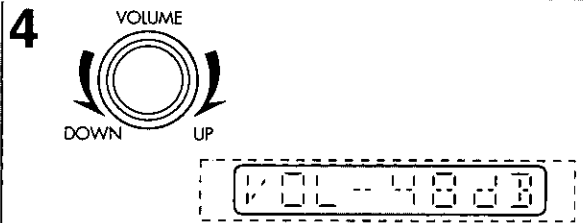
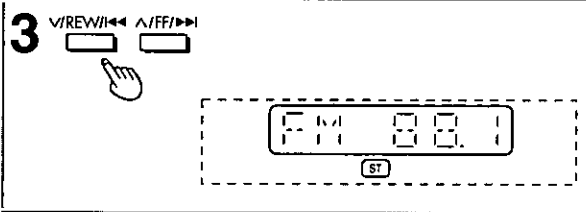
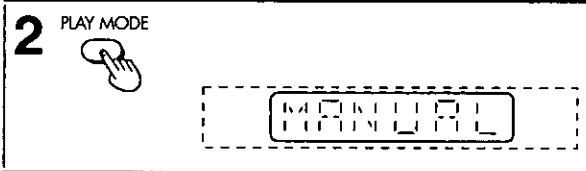
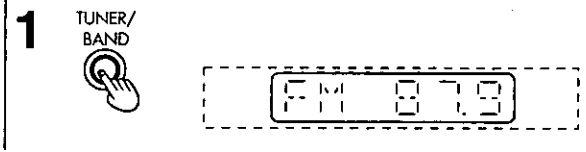
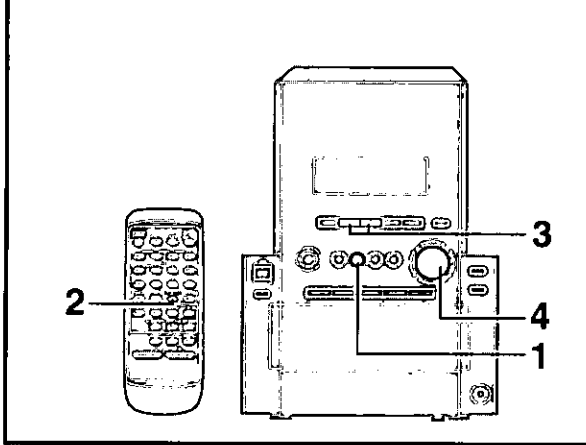

The radio: manual tuning

- 1** Press [TUNER/BAND] to select "FM" or "AM".
The unit comes on automatically.
Every time you press the button:
FM \leftrightarrow AM
- 2** Press [PLAY MODE] on the remote control to select "MANUAL".
Every time you press the button:
MANUAL \leftrightarrow PRESET
- 3** Press [$\sqrt{\text{REW}}/\lll$] or [$\wedge/\text{FF}/\ggg$] to select the frequency of the required station.
"ST" is displayed when a stereo FM broadcast is being received.
- 4** Adjust the volume.

Auto tuning

Press and hold [$\sqrt{\text{REW}}/\lll$] or [$\wedge/\text{FF}/\ggg$] for a moment until the frequency starts changing rapidly. The unit begins auto tuning, stopping when it finds a station.

- Auto tuning may not function when there is excessive interference.
- To cancel auto tuning, press [$\sqrt{\text{REW}}/\lll$] or [$\wedge/\text{FF}/\ggg$] once again.

A If noise is excessive in FM

By remote control only

Press and hold [PLAY MODE] to display "MONO".

This mode improves sound quality if reception is weak, but broadcasts will be heard in monaural.

Press and hold [PLAY MODE] again to cancel the mode. "MONO" goes out. MONO is also cancelled if the frequency is changed.

Turn off "MONO" for normal listening. Stereo and monaural broadcasts are automatically played as they are received.

FM allocation setting

By main unit only

By adjusting the allocation, you can enable this tuner to receive FM broadcasts allocated in 0.1 MHz steps.

Press and hold [TUNER/BAND]. After a few seconds, the display will change to a flashing display of the current minimum FM frequency. If you continue to hold the button down, the minimum frequency will change. Release the button at this time.

To return to the original frequency indication, repeat above.

Note

- After changing the "allocation" setting, the frequencies you previously preset in the memory will be cleared.
- Sound is momentarily interrupted if you load/unload a cassette while listening to an AM broadcast.

The radio: preset tuning

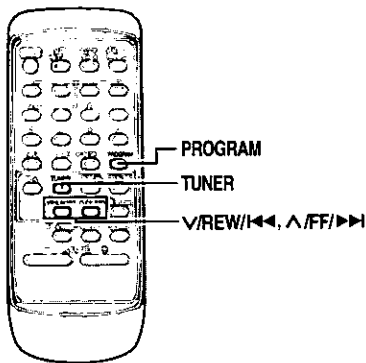

By remote control only

There are two methods of pre-setting stations.

Automatic presetting: All the stations the tuner can receive are preset.

Manual presetting: You can select the stations to pre-set and the order they are preset in.

Up to 15 stations each can be set in the FM and AM bands.

Preparation:

Press [TUNER] to select "FM" or "AM".

A PROGRAM

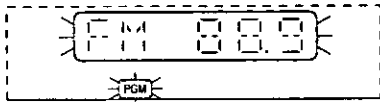

B

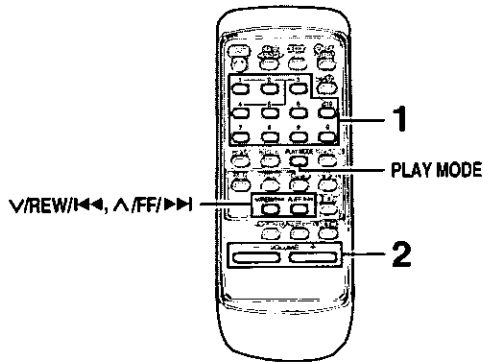

1

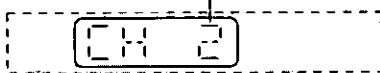
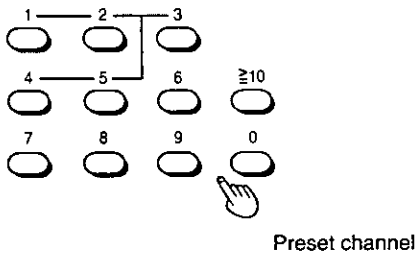

2



A Automatic pre-setting

Do the following once each for FM and AM.

Preparation:

Tune to the frequency where pre-setting is to begin (→ page 10).

Press and hold [PROGRAM].

The tuner presets all the stations it can receive into the channels in ascending order. When finished, the last station memorized is tuned in.

B Manual pre-setting

Pre-set the stations one at a time.

- ① Press [PROGRAM] then press [V/REW/◀◀] or [▲/FF/▶▶] to tune to the required station.
- ② Press [PROGRAM] then press [V/REW/◀◀] or [▲/FF/▶▶] to select a channel.
- ③ Press [PROGRAM].

The station occupying a channel is erased if another station is preset in that channel.

B Selecting channels

- 1 Press the numeric buttons to select the channel.

For channels 1 to 9, press the corresponding number. For channels 10 to 15, press [≥10], then the two digits.

OR

- ① Press [PLAY MODE] to select "PRESET".
- ② Press [V/REW/◀◀] or [▲/FF/▶▶] to select the channel.

- 2 Adjust the volume.

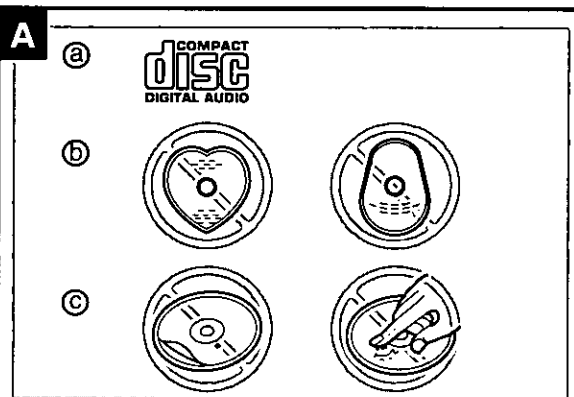
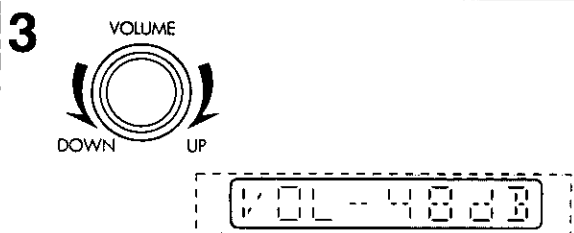
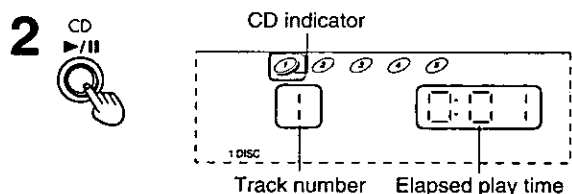
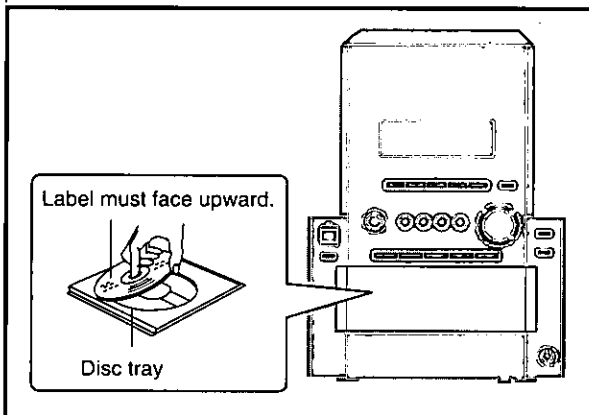
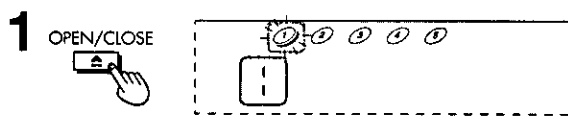
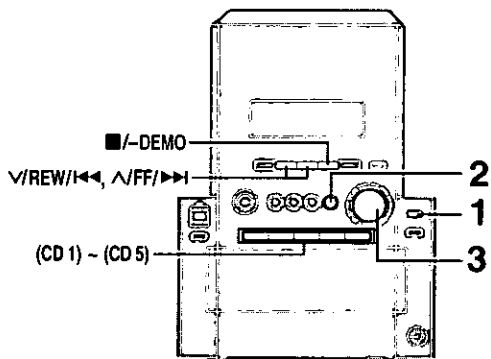

CDs

This unit can play CD-DA (digital audio) format audio CD-R and CD-RW that have been finalized (a process that enables CD-R/CD-RW players to play audio CD-R and CD-RW) upon completion of recording. It may not be able to play some CD-R or CD-RW due to the condition of the recording.

The unit contains five CD trays.

You can simply listen to the CD on a single tray, or you can select and listen to the CD on a particular tray. See the section on All-Disc play (→ page 14) for information on how to listen to all the CDs one after the next.

Listening to the CD on a single tray

1 Press [▲ OPEN/CLOSE] to open the disc tray and insert the CD.

The unit comes on automatically and tray 1 opens. Press [▲ OPEN/CLOSE] again to close the tray.

2 Press [▶/|| CD] to start play.

The selected CD is played from the first track to the last track in order. After the last track, the player stops automatically.

3 Adjust the volume.

To stop the disc

Press [■/-DEMO].

To pause play

Press [▶/|| CD]. Press [▶/|| CD] again to resume play.

Skipping tracks

Press [V/REW/I◀◀] (backward) or [^/FF/▶▶] (forward).

Searching through tracks

During play or pause

Press and hold [V/REW/I◀◀] (backward) or [^/FF/▶▶] (forward).

CD indicator

The CD indicator on the display lights whenever the tray is in the playing position whether it is loaded or not.

One touch play

If the unit is in standby mode and a CD is loaded, press [▶/|| CD] or [CD 1] ~ [CD 5].

The unit will come on automatically and play will start.

A CD selection and care

With this system, you can only play CDs having this mark. (a)

Do not;

- use irregularly shaped CDs. (b)
- attach extra labels and stickers.
- use CDs with labels and stickers that are coming off or with adhesive exuding from under labels and stickers. (c)
- attach scratch-proof covers or any other kind of accessory.
- write anything on the CD.
- clean CDs with liquids. (Wipe with a soft, dry cloth.)
- use CDs printed with labels available on the market.

To prevent damage

Always observe the following points.

- Set the system on a flat, level surface. Do not set it on top of magazines, inclined surfaces, etc.
- Do not move the system while tray is opening/closing, or when loaded. Always unload all CDs before moving the system.
- Do not put anything except a CD in the tray.
- Do not use cleaning CDs or CDs which are badly warped or cracked.
- Do not disconnect the power cord from the household AC outlet during CD changing operation.

Listening to a CD placed in a specific tray

Preparation: Press [▶/II CD] and then [■/-DEMO].

Selecting the desired tray number and placing a CD in it

- 1 Press [▲ CD CHANGE].
- 2 Within about 10 seconds Press [CD 1] – [CD 5] to open the tray and insert the CD.
Press [▲ CD CHANGE] again to close the tray.
Repeat steps 1 and 2 to insert other CDs. You can load up to 5 CDs.

Listening to the CD placed in a specific tray

- 3 Press [CD 1] – [CD 5] to start play.
The selected CD is played from the first track to the last track in order. After the last track, the player stops automatically.
- 4 Adjust the volume.

To remove the CD

While one CD is playing (except in All-Disc Random play or program play), you can change the CDs in the other trays.

- ① Press [▲ CD CHANGE].
- ② Press [CD 1] – [CD 5].
Press [▲ CD CHANGE] again to close the tray.

A To check which tray the CD is in (CD CHECK)

The CD check feature lets you check whether a 12cm CD is in a tray.

Press [CD CHECK].

If the player is stopped, all trays will open.

If a CD is being played, the corresponding tray will not open.

Press [CD CHECK] again to close the trays.

- Do not remove or insert CDs during a CD check.
- Do not pull out the trays during a CD check.

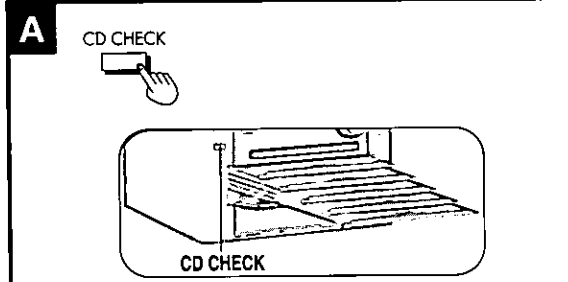
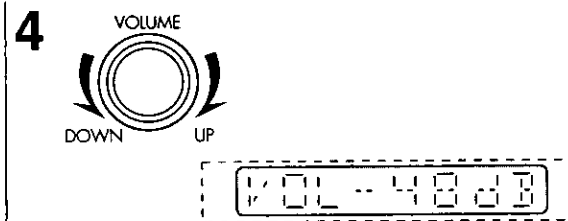
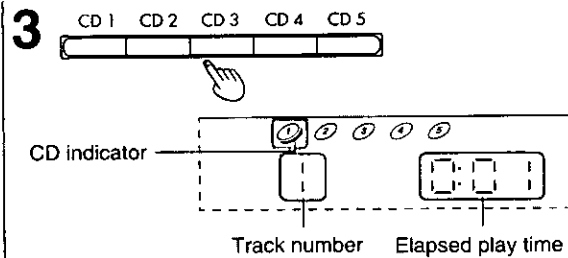
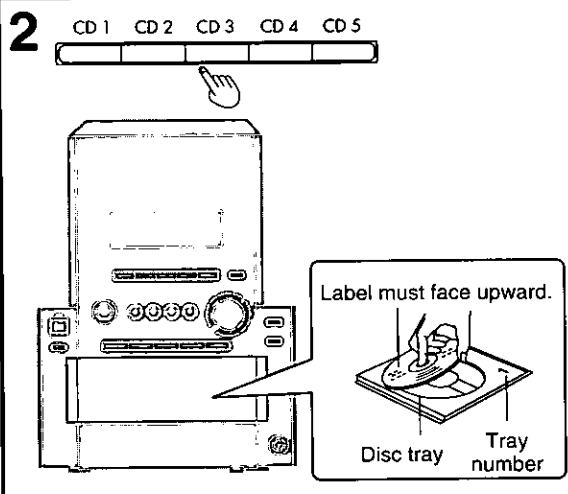
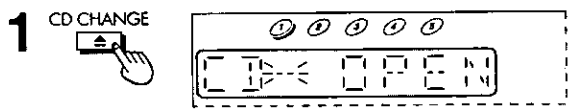
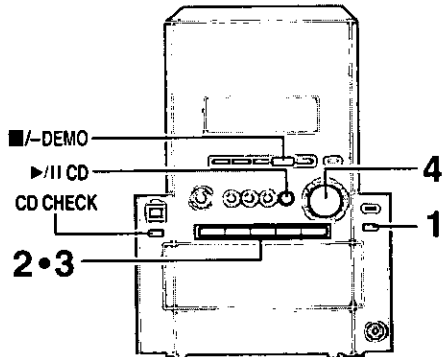

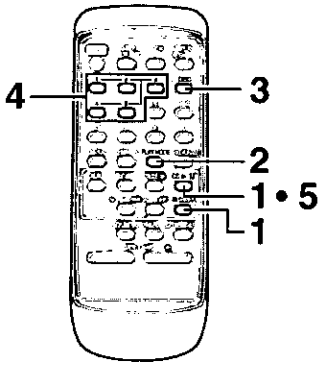

1 → **/CLEAR**

2 **PLAY MODE**

3 **DISC**

4

Specified disc indicator

5 **CD ►/II**

CDs

Listening to specific CDs and tracks (CD Play Mode function)

By remote control only

This function makes it easier for you to select specific CDs and tracks from those loaded in the player.

There are 4 disc/track selection modes.

- All-Disc mode : Plays all loaded discs in succession from the selected disc to the final disc ※.
- 1-Disc Random mode : Plays one selected disc in random order.
- All-Disc Random mode : Plays all loaded discs in random order.
- 1-Disc mode : Plays one selected disc.

- 1** Press [CD ►/II] and then [■ /CLEAR].
- 2** Press [PLAY MODE] to select the desired mode.

Every time you press the button:

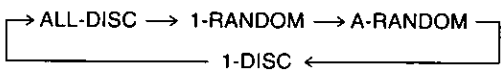

- ALL-DISC : All-Disc mode
 - 1-RANDOM : 1-Disc Random mode
 - A-RANDOM : All-Disc Random mode
 - 1-DISC : 1-Disc mode
- (The original display is restored in about 2 seconds.)

Note

Proceed to step 5 if A-RANDOM was selected in this step.

- 3** Press [DISC].
- 4** (Within 10 seconds) Press [1]-[5] to select the disc. The CD starts if 1-DISC, ALL-DISC or 1-RANDOM was selected in step 2.

Note

Step 5 is not required if 1-DISC, ALL-DISC or 1-RANDOM was selected in step 2.

- 5** Press [CD ►/II]. The CD starts.

To stop play

Press [■ /CLEAR].

When playback ends

The current play mode will be retained.

※ **Final disc**

For example, if play starts from disc 4, disc 3 will be the "final disc".

Order of progression:

Disc 4→5→1→2→3

Note

- You can use the CD Play Mode function together with repeat play.
- During 1-Disc Random play or All-Disc Random play, you cannot skip to tracks which have already been played.
- During 1-Disc Random play or All-Disc Random play, you can search forward or backward only within the current track.

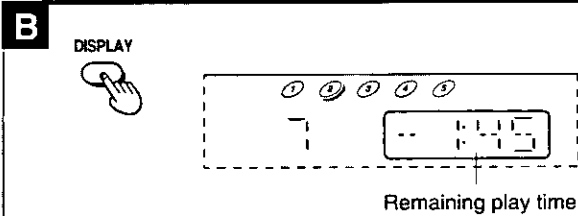
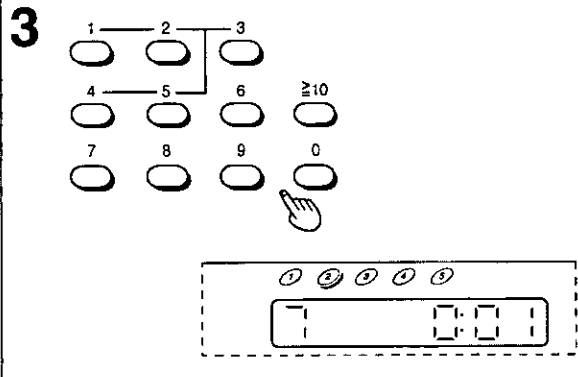
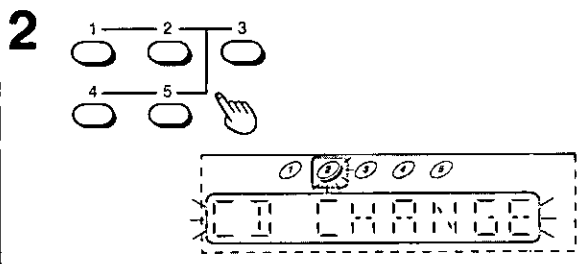
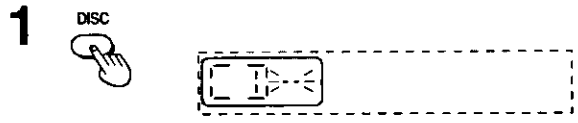
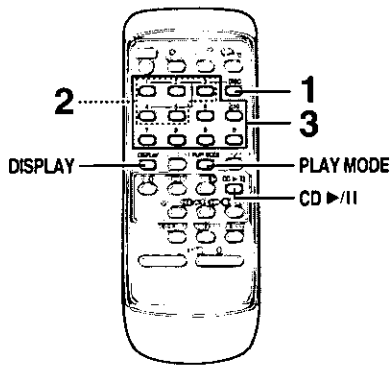

CDs

Direct access play

By remote control only

Direct access allows you to start normal play from a specific track to the last track of the CD.

- 1** Press [DISC].
- 2** (within 10 seconds or so)
Press [1] – [5] to select the disc you want.
- 3** Press the numeric button(s) to select the desired track number.
Play will start with the track you select.

To select a two-digit track

Press [≥10] and then the two numbers you want.

For example

Track no. 20: [≥10]→[2]→[0]

Track no. 35: [≥10]→[3]→[5]

Note

You cannot use direct access play with 1-RANDOM or A-RANDOM mode.

Repeat play

By remote control only

A Press and hold [PLAY MODE] before or during play.

"REPEAT ON" and "⏮" are displayed.

To cancel repeat play

Press and hold [PLAY MODE] once again. "REPEAT OFF" is displayed and "⏮" is cleared.

To repeat your favorite tracks

1. Program the tracks you want (perform steps 1 ~ 6 on page 16.)
2. Press and hold [PLAY MODE] and make sure "REPEAT ON" and "⏮" are displayed.
3. Press [CD ▶/II]. Playback will start.

To use repeat play with CD Play Mode function

Set the desired mode (→ page 14), press and hold [PLAY MODE] before or during playback, and make sure "REPEAT ON" and "⏮" are displayed.

B CD display

By remote control only

This function allows you to display the remaining play time of the current track.

During play or pause mode

Press [DISPLAY].

Every time you press the button:

Elapsed play time ↔ Remaining play time

Note

When track number 25 or greater is playing, remaining play time display shows "--:--".

Listening operations

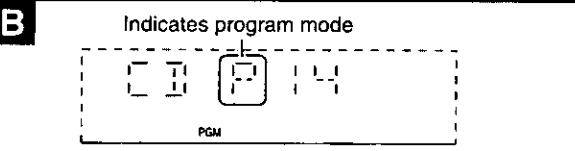
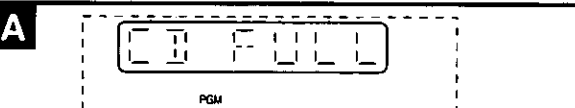
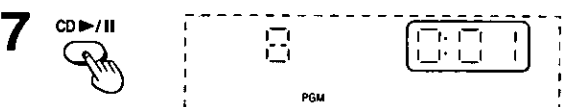
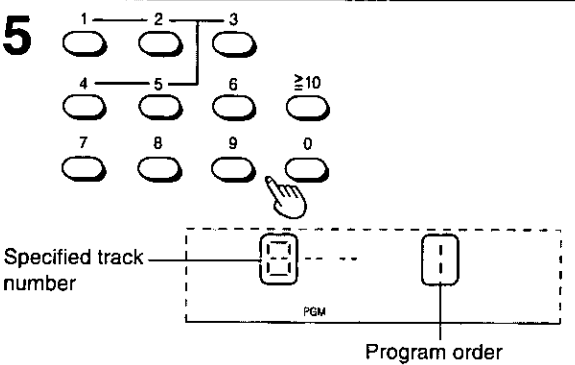
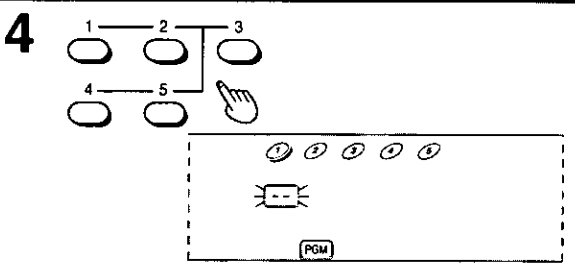
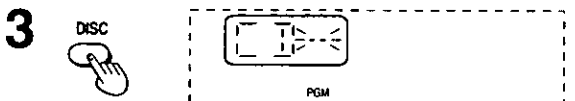
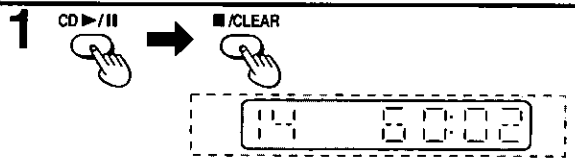
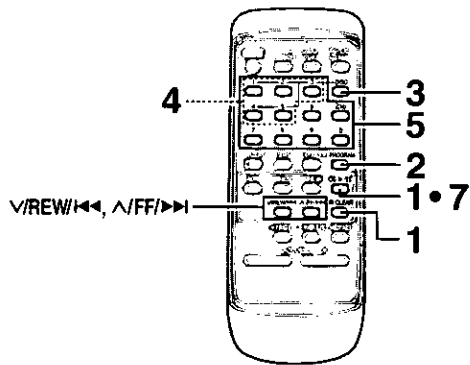

CDs

Program play

By remote control only

This function allows you to program up to 24 tracks.

- 1** Press [CD >/II] and then [■ /CLEAR].
- 2** Press [PROGRAM].
- 3** Press [DISC].
- 4** (within 10 seconds or so) Press [1] – [5] to select the disc you want.
- 5** Press the numeric button(s) to select the track you want to play in the desired sequence.
- 6** Repeat steps 3 through 5 until you have programmed all the tracks you want.
- 7** Press [CD >/II]. Play will start in the programmed sequence.

To cancel program play mode

Press [PROGRAM] in the stop mode. Programmed contents will be saved in memory.

To clear all programmed tracks

Press [■ /CLEAR] in the stop mode. "CLEAR" is displayed.

To select a two-digit track

Press [≥10] and then the two numbers you want.

A When "CD FULL" appears

The number of programmed tracks is limited to 24. No further tracks can be programmed.

B You can do the following during program mode:

- **Check program contents.**
Press [V/REW/II<<] or [/FF/>>].
Every time you press one of the buttons, the track and program No. are shown on the display.
- **Add to the program.**
Repeat steps 3 through 5.

Memory retention

Your program is retained in memory for about 1 week while the system is unplugged.

To replay your program

If you turned OFF your program with [PROGRAM], you can play it again as explained below.

1. Press [PROGRAM].
2. Press [CD >/II].

If you program a track not on your CDs

The track is initially programmed, but during program play, the player will skip that track and will continue playing from the next programmed item.

Note

- During program play, you can search forward or backward only within the current track.
- During program play, skipping is always in the programmed order, whether forward or backward.

Cassette tapes

- 1 Press [▲ OPEN], insert a cassette with the tape facing in.

When the button is pressed, the unit comes on automatically.

Make sure the cassette is fully inserted and close the lid by hand.

- 2 Press [▶ TAPE] to start playback.
- 3 Adjust the volume.

To stop tape playback

Press [■/-DEMO].

One-touch play

When the system is OFF and a cassette is already inserted, play starts automatically when you press [▶ TAPE].

Fast-forward and rewind

Press [V/REW/I◀◀] (rewind) or [^/FF/▶▶] (fast-forward).

Cassette tape selection and care

Types of tapes which can be played correctly.

The system automatically identifies the type of tape.

NORMAL POSITION/TYPE I	✓
HIGH POSITION/TYPE II	×
METAL POSITION/TYPE IV	×

High position and metal position tapes can be played, but the unit will not be able to do full justice to the characteristics of these tapes.

- Tapes exceeding 100 minutes are thin and can break or get caught in the mechanism.
- Tape slack can get caught up in the mechanism and should be wound up before the tape is played.
- Endless tapes can get caught up in the deck's moving parts if used incorrectly.

To find the beginning of a program (TPS: Tape Program Sensor)

TPS finds the beginning of a track and resumes play from there. Each press increases the number of tracks skipped, up to a maximum of 9.

Press [V/REW/I◀◀] or [^/FF/▶▶] during play.

Notes

The TPS function searches for silent parts of about 4 seconds in length which are normally found between tunes. As a result, it may not function properly in the following cases:

- With short silent parts
- When noise occurs between tunes
- With silent parts found within tunes

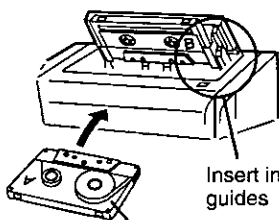
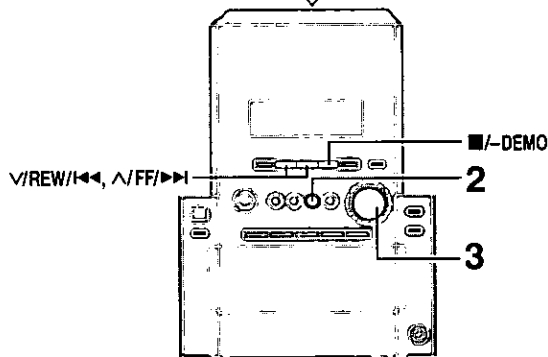
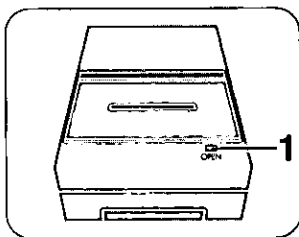

Forward side

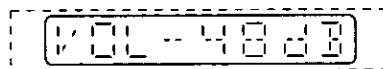
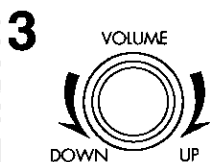
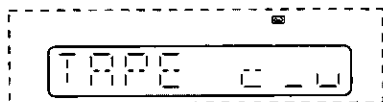

A To protect tapes against further recording

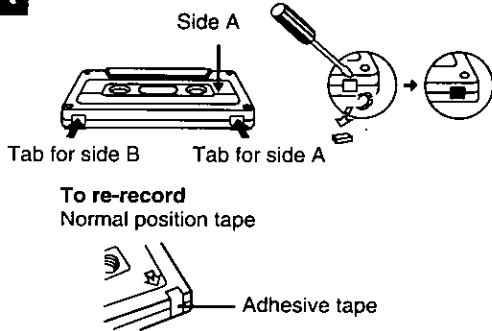

Before recording

Types of tapes which can be recorded correctly

The system automatically identifies the type of tape.

NORMAL POSITION/TYPE I	✓
HIGH POSITION/TYPE II	×
METAL POSITION/TYPE IV	×

High position and metal position tapes can be used, but the unit will not be able to record or erase them correctly.

A Erasure prevention

The illustration shows how to remove the tabs to prevent re-recording. To record on the tape again, cover as shown.

The effect of volume and sound quality on recording.

These have no effect on recording.
They can be changed for playback.

B To erase a recorded sound

- ① Press [▶ TAPE] and then [■/-DEMO].
- ② Insert the recorded cassette with the tape facing in.
- ③ Press [●REC/II].

C Preparatory steps

Do these steps before each recording.
Wind up the leader tape so recording can begin immediately.

Press [▲ OPEN], insert a cassette with the tape facing in.

Make sure the cassette is fully inserted and close the lid by hand.

B

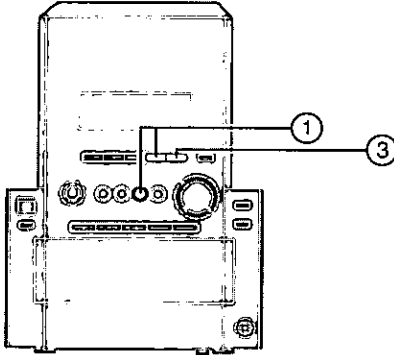

C

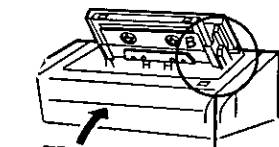
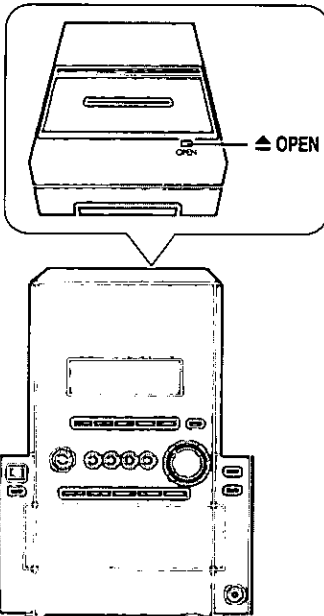

Insert inside the guides

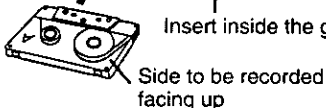

Side to be recorded facing up

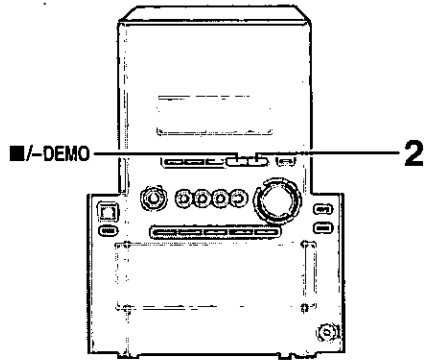
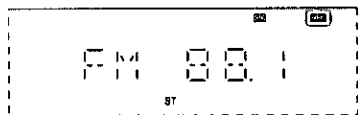
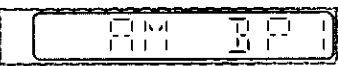
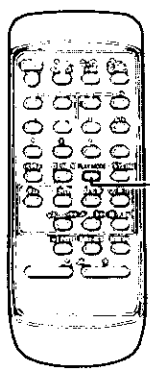
A**2****B**

PLAY MODE

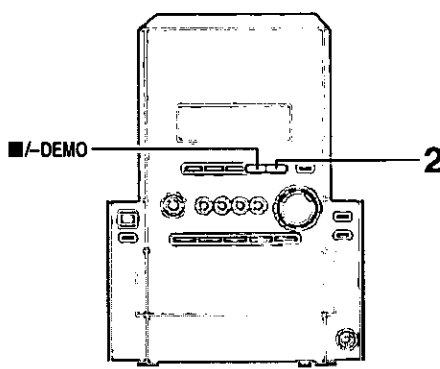
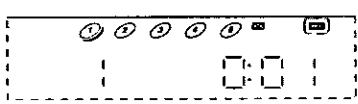
C**2****A Recording from the radio**

Preparation: Do the preparatory steps (⇒ page 18).

- 1 Tune to the required station.**
(⇒ page 10 or 11)
- 2 Press [●REC/II] to start recording.**

To stop recording
Press [■/-DEMO].

To stop recording temporarily
Press [●REC/II].
To resume recording, press [●REC/II].

To cut an unnecessary part while recording
1. Press [●REC/ II] during the unnecessary part. The cassette deck will go into the stop mode.
2. Press [●REC/ II] to resume recording again.

To record on the other side of the tape
Turn the tape over and press [●REC/II].

Note

When recording an AM broadcast, sound is momentarily interrupted when you start and stop the recording.

B To reduce noise while recording an AM broadcast (Beat proof function)**By remote control only**

Press and hold [PLAY MODE] while recording.
Every time you press the button:
BP1 ↔ BP2
Select the position where there is less noise.

C Recording CDs

You can use 1-DISC/ALL-DISC mode (⇒ page 14) to make recordings.

Preparation:

- Do the preparatory steps (⇒ page 18).
- Insert the CD(s) you want to record (⇒ page 12).

1-DISC/ALL-DISC recording

- 1 Do steps 1 to 4 on page 14.**
Ensure CD is stopped.
- 2 Press [●REC/II] to start recording.**
The CD starts.

To stop recording
Press [■/-DEMO].
CD play stops automatically.

To stop recording temporarily
Press [●REC/II].
To resume recording, press [●REC/II].

If the tape finishes before the CD
The CD continues playing. Press [■/-DEMO] to stop it.

To record programmed tracks
① Program the tracks (⇒ page 16).
② Press [●REC/II] to start recording.
Play starts.
To stop recording, press [■/-DEMO].
Disc play stops automatically.

Recording operations

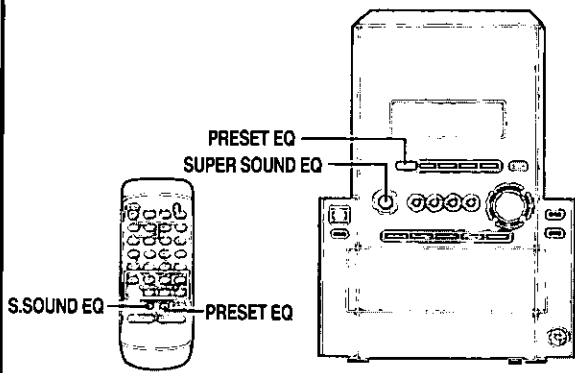

A PRESET EQ



HEAVY

B SC-PM27 SUPER SOUND EQ



SC-PM17 SUPER SOUND EQ



C

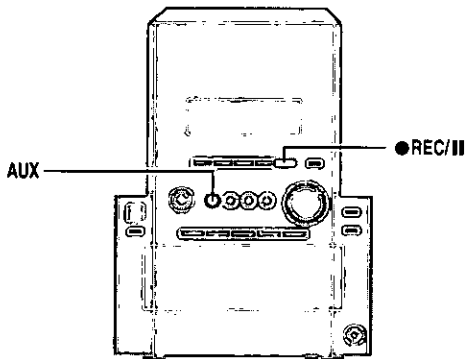

D

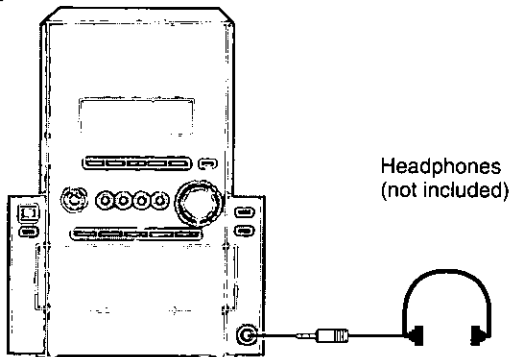

A Using the built-in sound quality settings

You can choose one of three types of sound quality.

- Ⓐ **HEAVY**: Adds punch to rock
- Ⓑ **CLEAR**: Clarifies higher sounds
- Ⓒ **SOFT**: For background music

Press [**PRESET EQ**] to select a setting.

Each time you press the button:

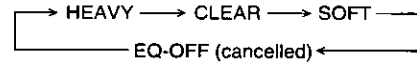

Note

- Preset EQ cannot be used together with Super Sound EQ.
- Changes to sound quality do not affect recordings.

B Enhancing the sound quality

This feature enhances the bass and treble effect of the sound.

Press [**SUPER SOUND EQ**].

Remote control: Press [**S.SOUND EQ**].

Press the button again to cancel.

The button light goes out (for SC-PM27 only).

C Using an external unit

Listening to an external source

(See page 7 for external unit connection.)

- ① Press [**AUX**].
- ② Start playback from the external source. (Refer to your equipment's operating instructions.)

Recording from an external source

- ① Insert the tape to be recorded on.
- ② Press [**AUX**].
- ③ Press [**REC/II**] (recording starts).
- ④ Start playback from the external source. (Refer to your equipment's operating instructions.)

D Listening with headphones

Reduce the volume level, and connect the headphones. Plug type: 3.5 mm (1/8") stereo.

Note

Avoid listening for prolonged periods of time to prevent hearing damage.

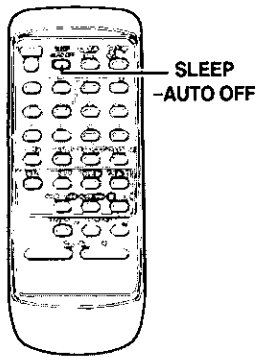
ASLEEP
-AUTO OFF

AUTO OFF

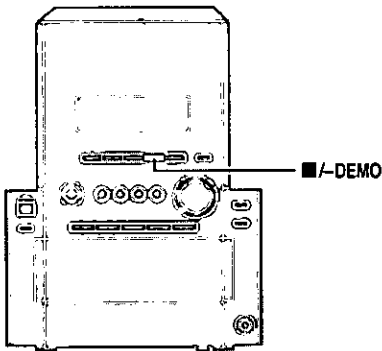
B

■/-DEMO

■/-DEMO

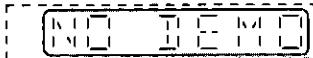
**A Auto-off function****By remote control only**

When CD or tape is selected as the source
To save power, the unit turns off if it is left unused for ten minutes.

Note

This function does not work if the source is tuner or AUX.

Press and hold [-AUTO OFF].

"AUTO OFF" is shown on the display.

To cancel

Press and hold [-AUTO OFF] again to clear "AUTO OFF" from the display.

For your reference

The setting is maintained even if the unit is turned off. When the unit is turned on again, "AUTO OFF" is displayed and the unit functions as described above.

"AUTO OFF" disappears from the display if either tuner or AUX is selected as the source but continues to function normally.

"AUTO OFF" remains displayed if CD or tape is selected as the source.

B Turning the demo function off

If the clock has not been set, a demonstration of the display is shown when the unit is switched to standby mode.
This function is set to on at the time of purchase.

During standby mode

Press and hold [■/-DEMO] until "NO DEMO" is displayed.

The display changes each time the button is held down.

NO DEMO (off) ↔ (demo on)

To show a demonstration of the display

Press and hold [■/-DEMO] until a demonstration of the display is shown.

Note

- You cannot turn demo function off when the unit is on.
- DEMO function cannot be turned on when Dimmer is on.

A

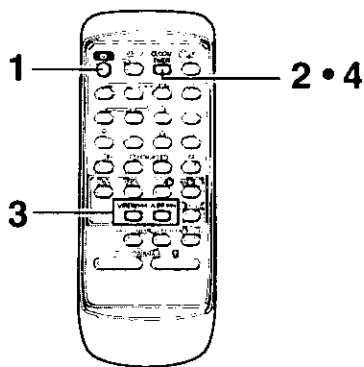

1



2

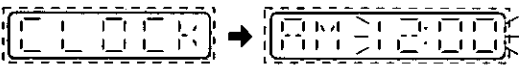

3



4

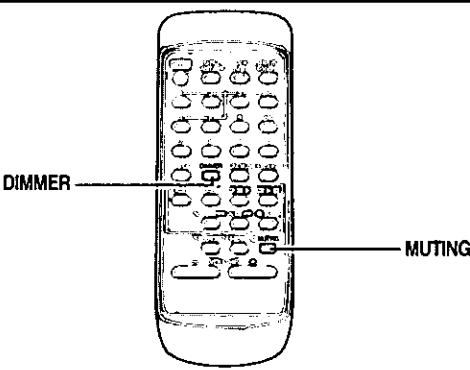

B



C



A Setting the time

By remote control only

This is a 12-hour clock.

The example shows how to set the clock for 6:30 p.m..

- 1** Press [⏻] to turn the unit on.
- 2** Press [CLOCK/TIMER] to select "CLOCK".
Every time you press the button:



- 3** Within 7 seconds
Press [REW/◀] or [FF/▶] to set the time.
Press and hold to change the time faster.
- 4** Press [CLOCK/TIMER].
The time is set and the original display is restored.

Displaying the clock when the unit is ON:

Press [CLOCK/TIMER].
The clock is shown for about 5 seconds.

Note

The clock may lose or gain some time over a period.
Readjust if necessary.

Convenient functions

B To dim the display panel

By remote control only

Use this when you are going to sleep or any other time you would prefer the panel to be dimmer.

Press [DIMMER].
The display dims and all lights are turned off except for the [AC IN] indicator and the backlight of the CD changer.

To cancel
Press [DIMMER] again.

C To mute the volume

By remote control only

This feature is convenient when you have a telephone call, etc.

Press [MUTING].
Press the button again to cancel. ("MUTING" goes out.)
Muting can also be cancelled by lowering the volume all the way to "--dB".
When the system is turned off, the muting operation will be automatically cancelled.

Using the timers

Using the play/record timer

By remote control only

The timer has two functions. It can be set to on at a certain time to wake you up, or it can be set to record from the radio or from the aux source.

The play timer cannot be used in combination with the record timer.

Preparations:

- Turn the unit on and set the clock (⇒ page 22).
- **For the play timer**, prepare the music source you want to listen to; tape, CD, radio or aux, and set the volume.
- **For the record timer**, check the cassette's erasure prevention tabs (⇒ page 18: **A**), insert the cassette and tune to the radio station (⇒ page 10) or select the aux source (⇒ page 20: **C**).

1 Press [CLOCK/TIMER] to select the timer function.

Every time you press the button:



⊙PLAY : to set the play timer

⊙REC : to set the record timer

Setting the start and finish times

2 (Within 8 seconds or so)

① Press [V/REW/◀◀] or [^/FF/▶▶] to select the starting time.

② Press [CLOCK/TIMER].

3 ① Press [V/REW/◀◀] or [^/FF/▶▶] to select the finishing time.

② Press [CLOCK/TIMER].

The start and finish times are now set.

Turning the timer on

4 Press [⊙PLAY/⊙REC].

Every time you press the button:



⊙PLAY : to turn the play timer on

⊙REC : to turn the record timer on

(The indicator doesn't appear if the start and finish times or the clock haven't been set.)

5 Press [⏻] to turn the unit off.

The unit must be off for the timers to operate.

• For play timer

The timer play will start at the preset time and volume level you preset.

• For record timer

The record timer comes on about 30 seconds earlier than the set time.

To cancel the timer

Press [⊙PLAY/⊙REC] to clear the timer indicators from the display.

The timer comes on at the set time everyday if the timer is on.

To change the settings (when unit is on)

• To change the play/record times

Do steps 1, 2, 3, and 5.

• To change the source or volume

① Press [⊙PLAY/⊙REC] to clear the timer indicator from the display.

② Make changes to the source or volume.

③ Do steps 4 to 5.

(Continued on next page)

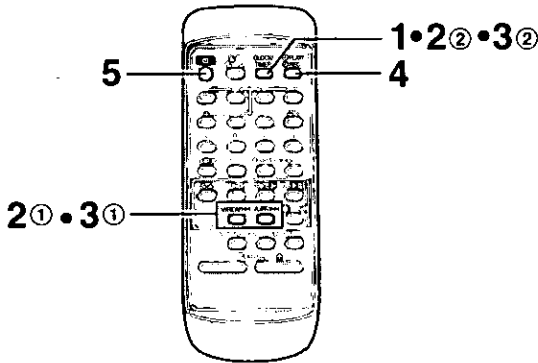

CLOCK/TIMER

FOR PLAY TIMER

FOR RECORD TIMER

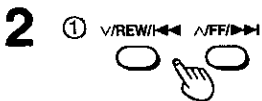
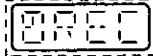
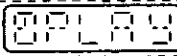

V/REW/FF

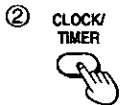
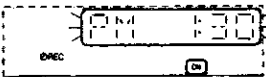
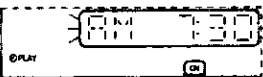

CLOCK/TIMER

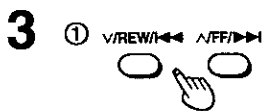

V/REW/FF

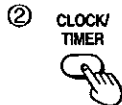
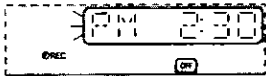
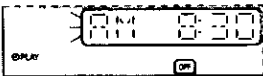

CLOCK/TIMER



⊙PLAY/⊙REC



⏻

A

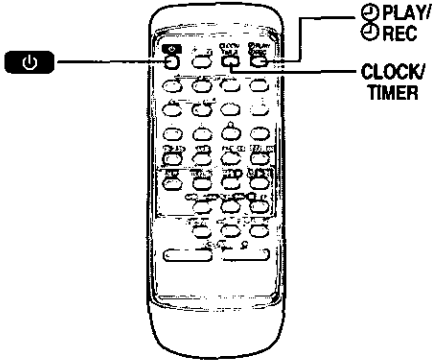

B

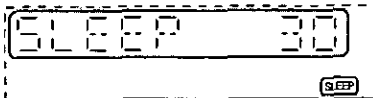
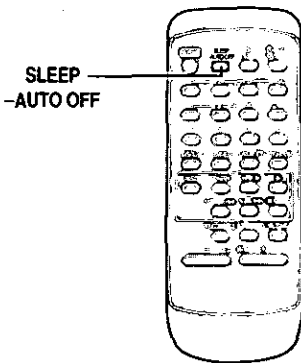

Using the timers

A Using the play/record timer

By remote control only

To check settings

While the unit is on and the "⊙PLAY" (or "⊙REC") indicator is on, press [CLOCK/TIMER] so "⊙PLAY" (or "⊙REC") appears on the display.

Two seconds after "⊙PLAY" (or "⊙REC") appear, the settings are displayed in the following order:

- For play timer
 - ① Play start time
 - ② Play finish time
 - ③ Play source
 - ④ Playback volume
- For record timer
 - ① Recording start time
 - ② Recording finish time
 - ③ Recording source

You can check the settings even when the system is OFF by pressing [CLOCK/TIMER] twice.

To enjoy the desired source after the timer setting is completed

The volume level (for play timer) and music source are stored in the timer memory and the timer will start in these preset conditions. However, the CD numbers do not get stored in the timer memory.

1. After step 4, start playing the desired source.
2. Reset the CD numbers if you have changed any of them, confirm that a CD or cassette is inserted, then press [⊙] to put the unit on standby.

Note

- If you turn the unit off and on again while a timer is functioning, the finish time setting will not be activated.
- If the unit is on, the timer will not function. The unit must be in the standby mode.
- If AUX is selected as the source, when the timer comes on, the system turns on and engages AUX as the source. If you want to playback or record from a connected unit, set the other unit's timer to the same time. (See the other unit's instruction manual.)

B Using the sleep timer

By remote control only

Set the unit to stop and turn off after a certain time.

While enjoying the desired source:

Press [SLEEP] to select the desired time.

Every time you press the button:

← SLEEP 30 → SLEEP 60 → SLEEP 90 → SLEEP 120 → SLEEP OFF →

To cancel the sleep timer

Press [SLEEP] to select "SLEEP OFF".

To confirm the remaining time

(only while unit is ON)

Press [SLEEP].

The remaining time is shown for about 5 seconds.

To change the time remaining during operation

Press [SLEEP] to show the remaining time, and then press [SLEEP] to select the desired time.

Note

- The sleep timer turns OFF automatically the moment you attempt to edit-record a CD.
 - The play and sleep timer or the record and sleep timer can be used together.
- The sleep timer always has priority. Be sure not to overlap timer settings.

Troubleshooting guide

Before requesting service, make the below checks. If you are in doubt about some of the check points, or if the remedies indicated in the chart do not solve the problem:

In the U.S.A., contact the Panasonic Customer Call Center at 1-800-211-7262, or e-mail consumerproducts@panasonic.com, or web site (<http://www.panasonic.com>).

In Canada, contact Panasonic Canada Inc. Customer Care Centre at 905-624-5505, web site (www.panasonic.ca), or an authorized Servicentre closest to you.

Reference pages are shown as black circled numbers ⑥.

Common Problems

No sound.	Turn the volume up. The speaker cords may be shorted. Turn the unit off, check and correct the connections and turn the unit on. ⑥
Sound is unfixed, reversed or comes from one speaker only.	Check the speaker connections. ⑥
Humming heard during play.	An AC power supply cord or fluorescent light is near the cables. Keep other appliances and cords away from this unit's cables.
"ERROR" is displayed.	Incorrect operation performed. Read the instructions and try again.
"- --:--" appears on the display.	You plugged the AC power supply cord in for the first time or there was a power failure recently. Set the time. ②
"F61" is displayed.	Check and correct the speaker cord connections. ⑥ If this does not fix the problem, there is a power supply problem. Consult the dealer.

Listening to the radio

Noise is heard. The stereo indicator flickers or doesn't light. Sound is distorted.	Use an outdoor antenna. ⑦
A beat sound is heard.	Turn the TV off or separate it from the unit.
A low hum is heard during AM broadcast.	Separate the antenna from other cables and cords.

When there is a television set nearby

The picture on the TV disappears or stripes appear on the screen.	The location and orientation of the antenna are incorrect. If you are using an indoor antenna, change to an outdoor antenna. ⑦ The TV antenna wire is too close to the unit. Separate the antenna wire of the TV set from the unit.
---	--

Using the cassette deck

Poor quality sound.	Clean the heads. back cover
Recording is not possible.	If the erasure prevention tabs have been removed, cover the holes with adhesive tape. ⑬

Playing discs

The display is wrong or play won't start.	The disc may be upside down. ⑫ Wipe the disc. Replace the disc if it is scratched, warped, or non-standard. Condensation may have formed inside the unit due to a sudden change in temperature. Wait about an hour for it to clear and try again.
The total number of tracks displayed differs each time the same disc is inserted. Unusual sound is heard.	The disc may be scratched, or its data may be defective. Replace the disc.
CD-RW cannot be read.	The disc was incompletely formatted. Use the recording equipment to fully format the disc before recording.

The remote control

Remote control doesn't work.	Check that the batteries are inserted correctly. ⑤ Replace the batteries if they are worn.
------------------------------	---

Warranty (ONLY FOR U.S.A.)

Panasonic Consumer Electronics Company,
Division of Matsushita Electric Corporation of America
One Panasonic Way Secaucus, New Jersey 07094

Panasonic Sales Company, Division of Matsushita Electric
of Puerto Rico, Inc.
Ave. 65 de Infantería, Km. 9.5
San Gabriel Industrial Park, Carolina, Puerto Rico 00985

Panasonic/Technics Audio Products Limited Warranty

Limited Warranty Coverage

If your product does not work properly because of a defect in materials or workmanship, Panasonic Consumer Electronics Company or Panasonic Sales Company (collectively referred to as "the warrantor") will, for the length of the period indicated on the chart below, which starts with the date of original purchase ("warranty period"), at its option either (a) repair your product with new or refurbished parts, or (b) replace it with a new or a refurbished product. The decision to repair or replace will be made by the warrantor.

Product or Part Name	Parts	Labor
Audio Products (except items listed below)	One (1) year	One (1) year
All Audio Racks (cabinets)	Thirty (30) days	Not Applicable
Technics Stand Alone Speakers, Subwoofer Speakers	Three (3) years	Three (3) years
USB Reader-Writer, Personal Computer Card Adapters (in exchange for defective item)	One (1) year	Not Applicable
Accessories: Headphones, Cartridges, Microphones, Adapters	Ninety (90) days	Ninety (90) days
Rechargeable Batteries (in exchange for defective item)	Ten (10) days	Not Applicable
SD Memory Cards, Rechargeable Battery Packs (in exchange for defective item)	Ninety (90) days	Not Applicable

During the "Labor" warranty period there will be no charge for labor. During the "Parts" warranty period, there will be no charge for parts. You must carry-in or mail-in your product during the warranty period. If non-rechargeable batteries are included, they are not warranted. This warranty only applies to products purchased and serviced in the United States or Puerto Rico. This warranty is extended only to the original purchaser of a new product which was not sold "as is". A purchase receipt or other proof of the original purchase date is required for warranty service.

Carry-In or Mail-In Service

For Carry-In or Mail-In Service in the United States call 1-800-211-PANA (1-800-211-7262) or visit Panasonic web site: <http://www.panasonic.com>

For assistance in Puerto Rico call Panasonic Sales Company (787)-750-4300 or fax (787)-768-2910.

Limited Warranty Limits And Exclusions

This warranty ONLY COVERS failures due to defects in materials or workmanship, and DOES NOT COVER normal wear and tear or cosmetic damage. The warranty ALSO DOES NOT COVER damages which occurred in shipment, or failures which are caused by products not supplied by the warrantor, or failures which result from accidents, misuse, abuse, neglect, mishandling, misapplication, alteration, faulty installation, set-up adjustments, misadjustment of consumer controls, improper maintenance, power line surge, lightning damage, modification, or commercial use (such as in a hotel, office, restaurant, or other business), rental use of the product, service by anyone other than a Factory Servicer or other Authorized Servicer, or damage that is attributable to acts of God.

THERE ARE NO EXPRESS WARRANTIES EXCEPT AS LISTED UNDER "LIMITED WARRANTY COVERAGE". THE WARRANTOR IS NOT LIABLE FOR INCIDENTAL OR CONSEQUENTIAL DAMAGES RESULTING FROM THE USE OF THIS PRODUCT, OR ARISING OUT OF ANY BREACH OF THIS WARRANTY. (As examples, this excludes damages for lost time, travel to and from the servicer, loss of media or images, data or other memory content. The items listed are not exclusive, but are for illustration only.) **ALL EXPRESS AND IMPLIED WARRANTIES, INCLUDING THE WARRANTY OF MERCHANTABILITY, ARE LIMITED TO THE PERIOD OF THE LIMITED WARRANTY.**

Some states do not allow the exclusion or limitation of incidental or consequential damages, or limitations on how long an implied warranty lasts, so the exclusions may not apply to you.

This warranty gives you specific legal rights and you may also have other rights which vary from state to state. If a problem with this product develops during or after the warranty period, you may contact your dealer or Servicer. If the problem is not handled to your satisfaction, then write to the warrantor's Consumer Affairs Department at the addresses listed for the warrantor.

PARTS AND SERVICE WHICH ARE NOT COVERED BY THIS LIMITED WARRANTY ARE YOUR RESPONSIBILITY.

Reference

For Product Information, Operating Assistance, Literature Request, Dealer Locations, and all Customer Service inquiries please contact:

1-800-211-PANA (7262), Monday-Friday 9 am-9 pm; Saturday-Sunday 9 am-7 pm, EST.

*Web Site: <http://www.panasonic.com>
You can purchase parts, accessories or locate your nearest servicer by visiting our Web Site.*

Accessory Purchases:

1-800-332-5368 (Customer Orders Only)

Panasonic Services Company 20421 84th Avenue South, Kent, WA 98032

(6 am to 5 pm Monday-Friday; 6 am to 10:30 am Saturday; PST)

(Visa, MasterCard, Discover Card, American Express, Check)

Service in Puerto Rico

Matsushita Electric of Puerto Rico, Inc. Panasonic Sales Company/Factory Servicer:

Ave. 65 de Infantería, Km. 9.5, San Gabriel Industrial Park, Carolina, Puerto Rico 00985

Phone (787) 750-4300 Fax (787) 768-2910

Specifications

AMPLIFIER SECTION **SC-PM27**

Power output	
10% Total harmonic distortion	
60 Hz–120 Hz, both channels driven	
(Low channel)	18 W per channel (6Ω)
120 Hz–16 kHz, both channels driven	
(High channel)	22 W per channel (6Ω)
Total Bi-Amp power	40 W per channel
Power output	
10% Total harmonic distortion	
100 Hz, both channels driven	
(Low channel)	27 W per channel (6Ω)
1 kHz, both channels driven	
(High channel)	28 W per channel (6Ω)
Total Bi-Amp power	55 W per channel
Input sensitivity	
AUX	250 mV
Input Impedance	
AUX	11.8 kΩ

AMPLIFIER SECTION **SC-PM17**

Power output	
10% Total harmonic distortion	
60 Hz–3 kHz, both channels driven	
(Low channel)	15 W per channel (6Ω)
3 kHz–16 kHz, both channels driven	
(High channel)	20 W per channel (6Ω)
Total Bi-Amp power	35 W per channel
Power output	
10% Total harmonic distortion	
1 kHz, both channels driven	
(Low channel)	25 W per channel (6Ω)
8 kHz, both channels driven	
(High channel)	25 W per channel (6Ω)
Total Bi-Amp power	50 W per channel
Input sensitivity	
AUX	250 mV
Input Impedance	
AUX	11.8 kΩ

FM TUNER SECTION

Frequency range	
	87.9 – 107.9 MHz (200 kHz steps)
	87.5 – 108.0 MHz (100 kHz steps)
Sensitivity	2.5 μV (IHF)
S/N 26 dB	2.2 μV
Antenna terminal(s)	75 Ω (unbalanced)

AM TUNER SECTION

Frequency range	
	520 – 1710 kHz (10 kHz steps)
Sensitivity	
S/N 20 dB (at 1000 kHz)	560 μV/m

CASSETTE DECK SECTION

Track system	4 track, 2 channel
Heads	
Record/playback	Solid permalloy head
Erasur	Double gap ferrite head
Motor	DC servo motor
Recording system	AC bias 100 kHz
Erasing system	AC erase 100 kHz
Tape speed	4.8 cm/s (1 ⁷ / ₈ ips)
Overall frequency response	
(+3 dB, –6 dB at DECK OUT)	
NORMAL (TYPE I)	35 Hz – 14 kHz
S/N	50 dB (A weighted)
Wow and flutter	0.18% (WRMS)
Fast forward and rewind time	
	Approx. 120 seconds with C-60 cassette tape

CD SECTION

Sampling frequency	44.1 kHz
Decoding	16 bit linear
Beam source/wavelength	Semiconductor laser/780 nm
Number of channels	Stereo
Frequency response	20 Hz–20 kHz (+1, –2 dB)
Wow and flutter	Below measurable limit
Digital filter	8 fs
D/A converter	MASH (1 bit DAC)

SPEAKER SECTION **SB-PM27**

Type	3 way speaker system
Speaker(s)	
Super woofer	10 cm (4") cone type
Woofer	8 cm (3 ¹ / ₈ ") cone type
Tweeter	6 cm (2 ³ / ₈ ") cone type
Impedance	
HIGH	6 Ω
LOW	6 Ω
Input power	
HIGH	70 W (Music)
LOW	70 W (Music)
Output sound pressure level	86 dB/W (1.0 m)
Cross over frequency	110 Hz, 5 kHz
Frequency range	55 Hz–30 kHz (–16 dB)
	75 Hz–25 kHz (–10 dB)
Dimensions (WxHxD)	149 x 244 x 240 mm
	(5 ⁷ / ₈ " x 9 ¹³ / ₃₂ " x 9 ⁷ / ₁₆ ")
Mass	2.5 kg (5.5 lb.)

SPEAKER SECTION **SB-PM17**

Type	2 way speaker system
Speaker(s)	
Woofer	10 cm (4") cone type
Tweeter	6 cm (2 ³ / ₈ ") cone type
Impedance	
HIGH	6 Ω
LOW	6 Ω
Input power	
HIGH	50 W (Music)
LOW	50 W (Music)
Output sound pressure level	84 dB/W (1.0 m)
Cross over frequency	3 kHz
Frequency range	50 Hz–22 kHz (–16 dB)
	70 Hz–20 kHz (–10 dB)
Dimensions (WxHxD)	132 x 244 x 227 mm
	(5 ³ / ₁₆ " x 9 ¹³ / ₃₂ " x 8 ¹⁵ / ₁₆ ")
Mass	2 kg (4.4 lb.)

GENERAL

Power supply	AC 120 V, 60 Hz
Power consumption	85 W
Standby	Approx. 0.5 W
Dimensions (WxHxD)	179 x 241 x 375 mm
	(7 ¹ / ₁₆ " x 9 ¹ / ₂ " x 14 ³ / ₄ ")
Mass	5.6 kg (12.3 lb.)

Notes:

- Specifications are subject to change without notice. Mass and dimensions are approximate.
- Total harmonic distortion is measured by the digital spectrum analyzer.
- The labels "HIGH (HF)" and "LOW (LF)" on the rear of the speakers refer to High frequency and Low frequency.

Product Service

- 1. Damage requiring service**—The unit should be serviced by qualified service personnel if:
 - (a) The AC power supply cord or AC adaptor has been damaged; or
 - (b) Objects or liquids have gotten into the unit; or
 - (c) The unit has been exposed to rain; or
 - (d) The unit does not operate normally or exhibits a marked change in performance; or
 - (e) The unit has been dropped or the cabinet damaged.
- 2. Servicing**—Do not attempt to service the unit beyond that described in these operating instructions. Refer all other servicing to authorized servicing personnel.
- 3. Replacement parts**—When parts need replacing ensure the servicer uses parts specified by the manufacturer or parts that have the same characteristics as the original parts. Unauthorized substitutes may result in fire, electric shock, or other hazards.
- 4. Safety check**—After repairs or service, ask the servicer to perform safety checks to confirm that the unit is in proper working condition.

Product information

For product information or assistance with product operation:

In the U.S.A., contact the Panasonic Customer Call Center at 1-800-211-7262, or e-mail consumerproducts@panasonic.com, or web site (<http://www.panasonic.com>).

In Canada, contact Panasonic Canada Inc. Customer Care Centre at 905-624-5505, web site (www.panasonic.ca), or an authorized Servicentre closest to you.

Maintenance

If the surfaces are dirty

To clean this unit, wipe with a soft, dry cloth.

- Never use alcohol, paint thinner or benzene to clean this unit.
- Before using chemically treated cloth, read the instructions that came with the cloth carefully.

For a cleaner crisper sound

Clean the heads regularly to assure good quality playback and recording.

Use a cleaning tape (not included).

When moving the unit

- 1 Remove all discs.**
- 2 Press [⏻/I POWER] to turn the unit off.**
- 3 Disconnect the AC power supply cord.**



As an ENERGY STAR® Partner, Panasonic has determined that this product meets the ENERGY STAR® guidelines for energy efficiency.

Panasonic Consumer Electronics Company, Division of Matsushita Electric Corporation of America
One Panasonic Way Secaucus,
New Jersey 07094
<http://www.panasonic.com>

Panasonic Sales Company, Division of Matsushita Electric of Puerto Rico, Inc. ("PSC")
Ave. 65 de Infantería, Km. 9.5
San Gabriel Industrial Park, Carolina,
Puerto Rico 00985

Panasonic Canada Inc.
5770 Ambler Drive
Mississauga, Ontario
L4W 2T3
www.panasonic.ca

